



FIT IoT-lab

FIT IoT-LAB

First Class IoT Open Experimental Testbed

E. Fleury, ENS de Lyon / Inria

Workshop Internet Of Things / Equipex FIT IoT-LAB
Lille France — October 14-15, 2015



Thanks to :

- ▶ C. Adjih, Inria
- ▶ E. Baccelli, Inria
- ▶ C. Chaudet, Institut Mines-Télécom
- ▶ N. Mitton, Inria
- ▶ T. Noel, University of Strasbourg

1

IoT promise

Connected objects in a numerical world

$$2^{128} =$$

340.282.366.920.938.463.463.374.607.431.768.211.456

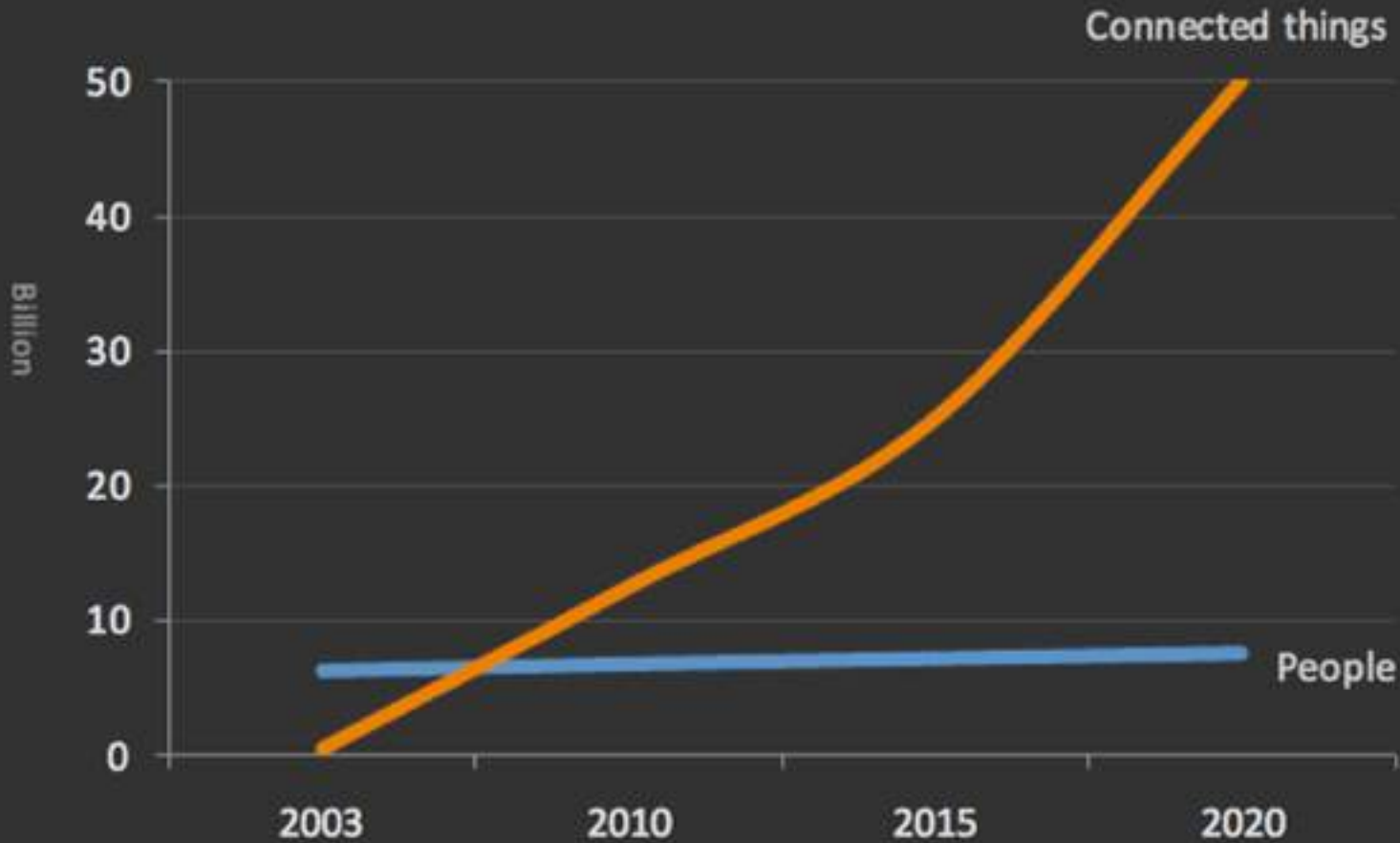

Source: Cisco IoT 2011 infographic

Instrumented

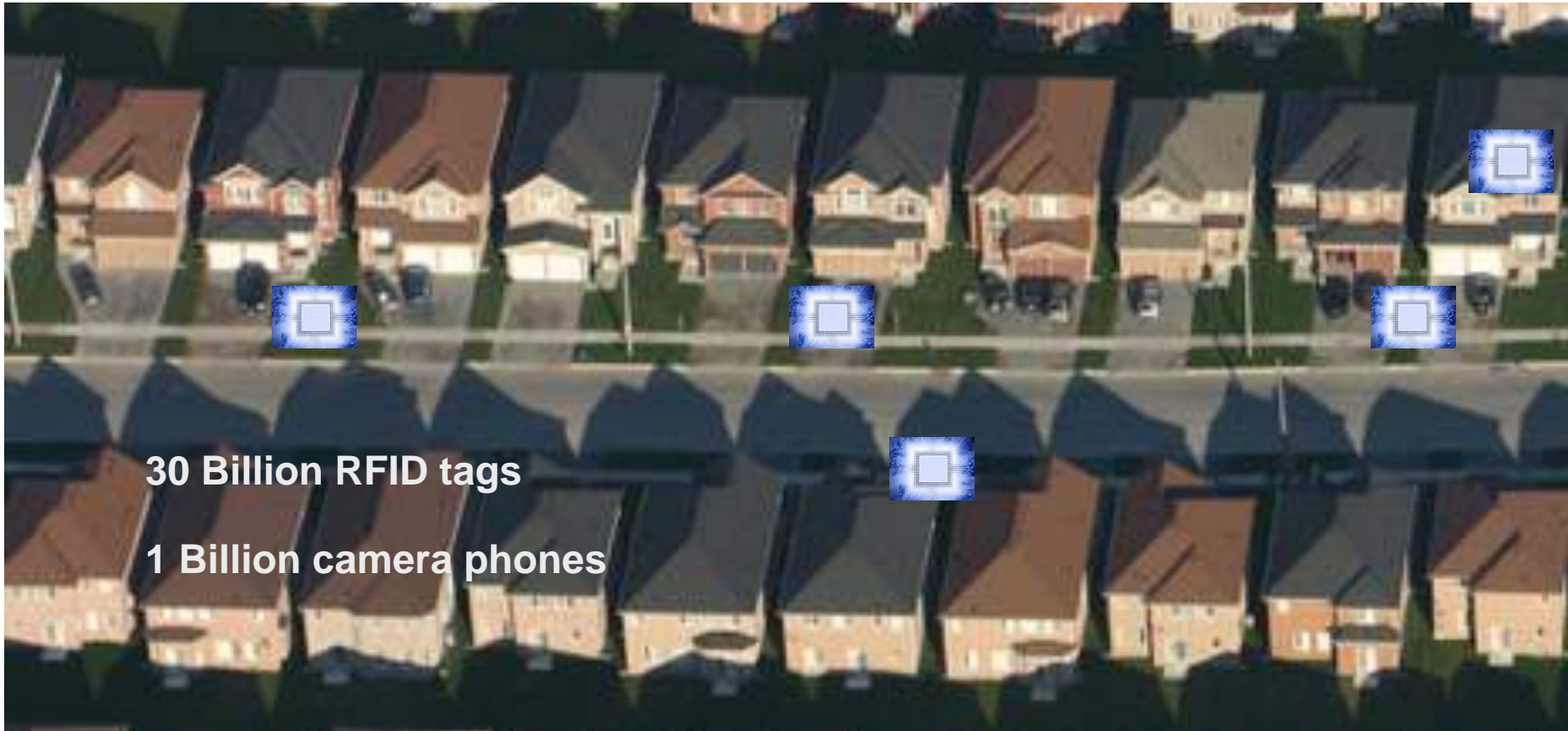

30 Billion RFID tags

1 Billion camera phones

source: Kim Escherich , Executive Innovation Architect sur Pan-European Chief Technology Officer Team, IBM SWG



How google traffic is working?

How to monitor road condition « for free »?

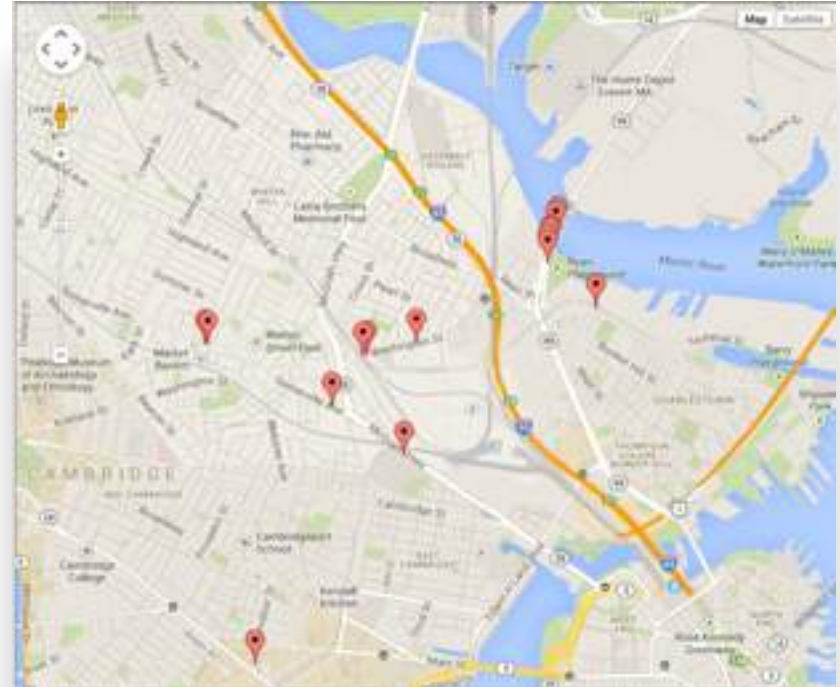

Potholes

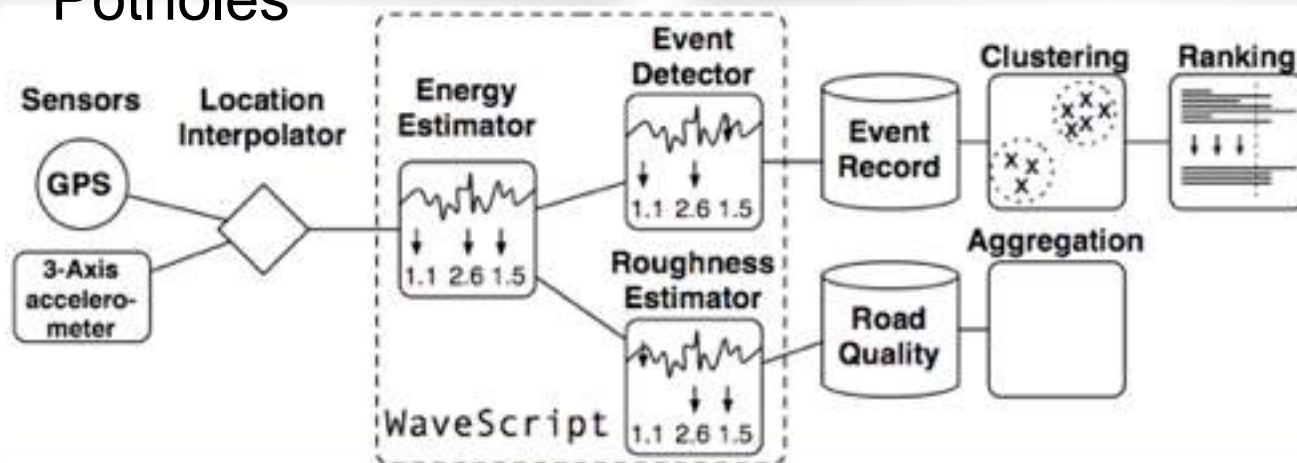

Interconnected



+2 Billions Internet subscribers

+20 Billion connected device

source: Kim Escherich , Executive Innovation Architect sur Pan-European Chief Technology Officer Team, IBM SWG

Intelligent



Every systems is becoming

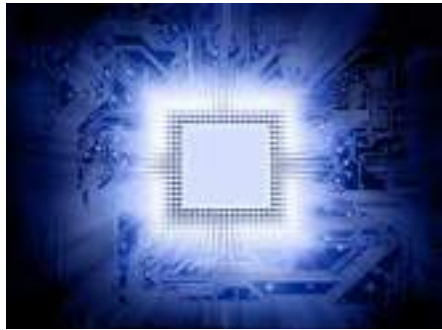

+



+



**NEW
INTELLIGENCE**

**SMART
WORK**

GREEN

**DYNAMIC
INFRASTRUCTURE**

IoT Acceleration Dashboard 2012-2014

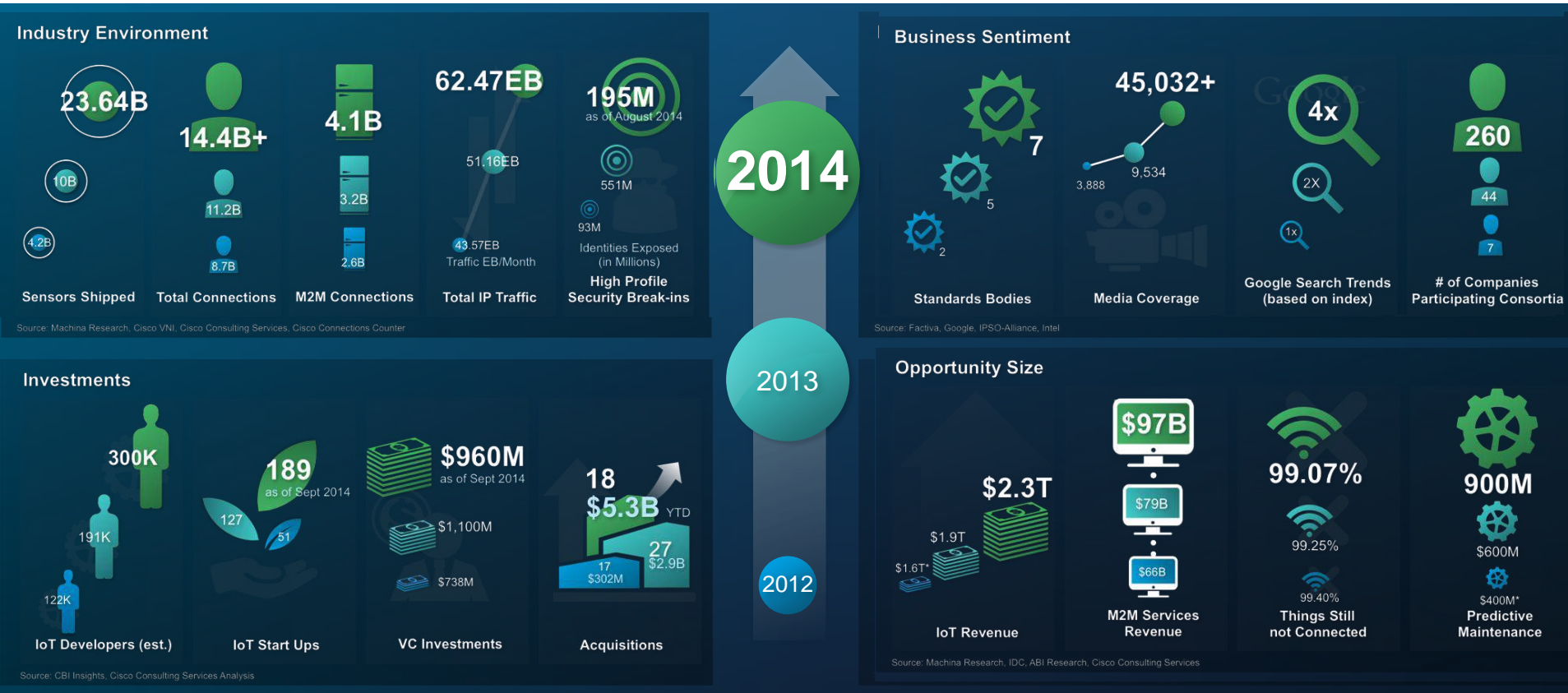

Source: CBI Insights, Cisco Consulting Services Analysis

First takeaways

1. **IoT Is Here.** Now. And It's Big
2. IoT Dashboard: **IoT is Accelerating**
3. **IoT... Huge Opportunity for Ecosystem**

Health
Home
Ecology
Security
Transport
Maintenance

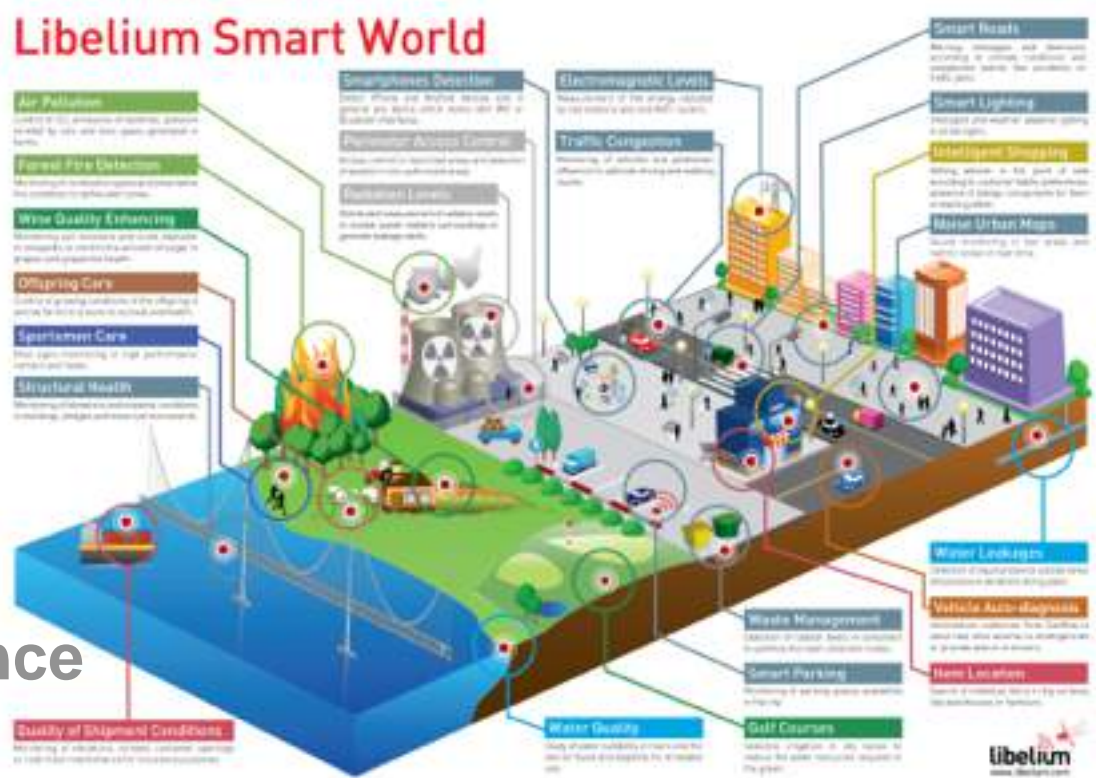

Deploying real applications

Build new protocols / applications

Specification / Design

Simulation

Deployment / Experimentation



HiKoB



HiKoB

Large scale experimentation is real nightmare

Fastidious for a dozen of nodes

Manual handling / time consuming / boring

Needs for large scale scientific tools

Scientific & Reproducible experiment

2

FIT IoT-LAB in the IoT Context

WHAT / WHERE / WHY / HOW

FIT IoT LAB Objectives

- ▶ **Target and challenge:**

- ▶ M2M / scaling

- ▶ IoT (heterogenous)

- ▶ **Designing / Testing / Deploying / Monitoring**



- ▶ **Use Cases:**

- ▶ Home Gateway

- ▶ Cloud service monitoring

- ▶ IPv6 from sensors to the
Cloud

- ▶ Mobile nodes

What/Where is FIT IoT LAB?

- ▶ More than 2700+ wireless nodes
 - ▶ IMS band
 - ▶ IEEE 802.15.4
- ▶ Low Power and Lossy Networks
- ▶ Total Remote Access
- ▶ Total Open Access
- ▶ Mobile Nodes/Robots



Ten Commandments

OPEN Nodes == NO CONSTRAINTS AT ALL

- I. Total remote access to open nodes
- II. Direct access to debugger
- III. Access to serial port / aggregator
- IV. On the global Internet (IPv6 end-to-end)



External Monitoring == NO APP MODIFICATION

- v. Packet sniffer
- vi. Precise end-to-end synchronisation (GPS)
- vii. Accurate power consumption



Easy to use / Advance features

- viii. OS supports, tutorials, Open-source (OpenWSN)
- ix. Fleet of robots (40 + 60 + 10)
- x. Free open slots for specific hardware (usb node)



IoT LAB Nodes

- ▶ A8 node : TI-SITARA AM3505
 - ▶ Ethernet, USB
 - ▶ Linux/Android
 - ▶ Indoor GPS for highly accurate synchronisation

- ▶ M3 node : STM32
 - ▶ Radio Atmel AT86RF231
 - ▶ Ambient light, Temp, IMU, Pressure

- ▶ WSN430 node : TI MSP430
 - ▶ Radio TI CC1101 / CC2420
 - ▶ Ambient light, Temp

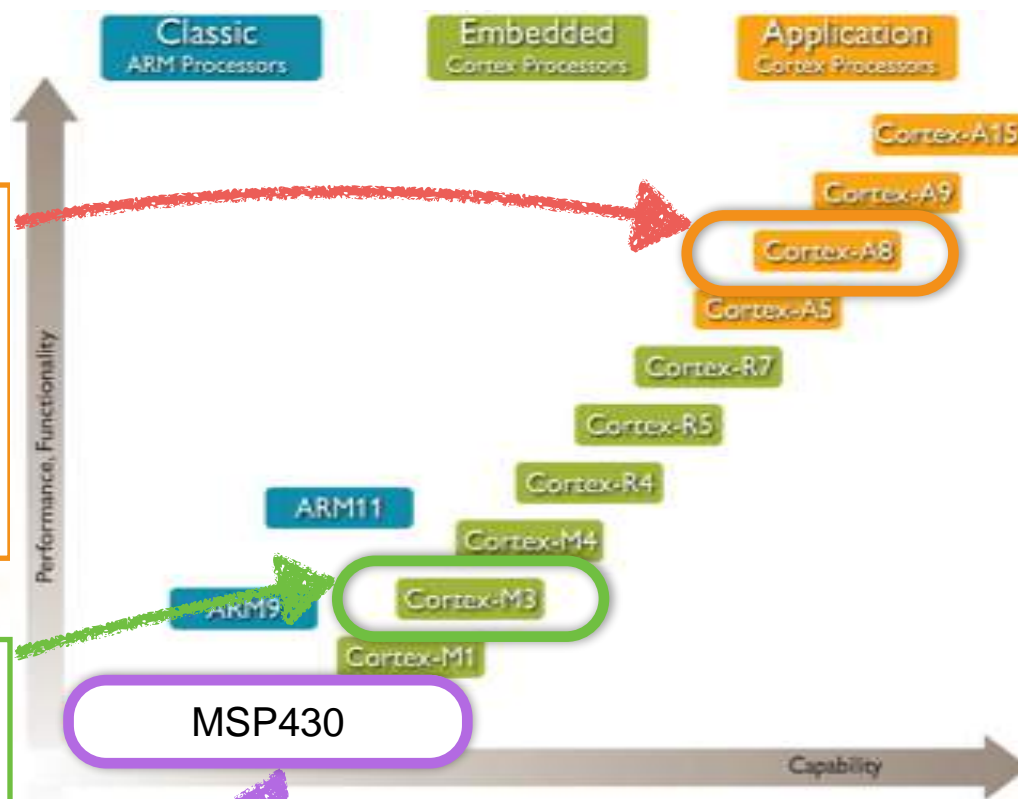

IoT-LAB Node

- ▶ Automatic firmware deployment
- ▶ Consumption Monitoring
- ▶ Sensor polling
- ▶ Radio sniffer

- ▶ Feedback channel
- ▶ Power over ethernet
- ▶ SINK / Internet connexion
- ▶ USB for external

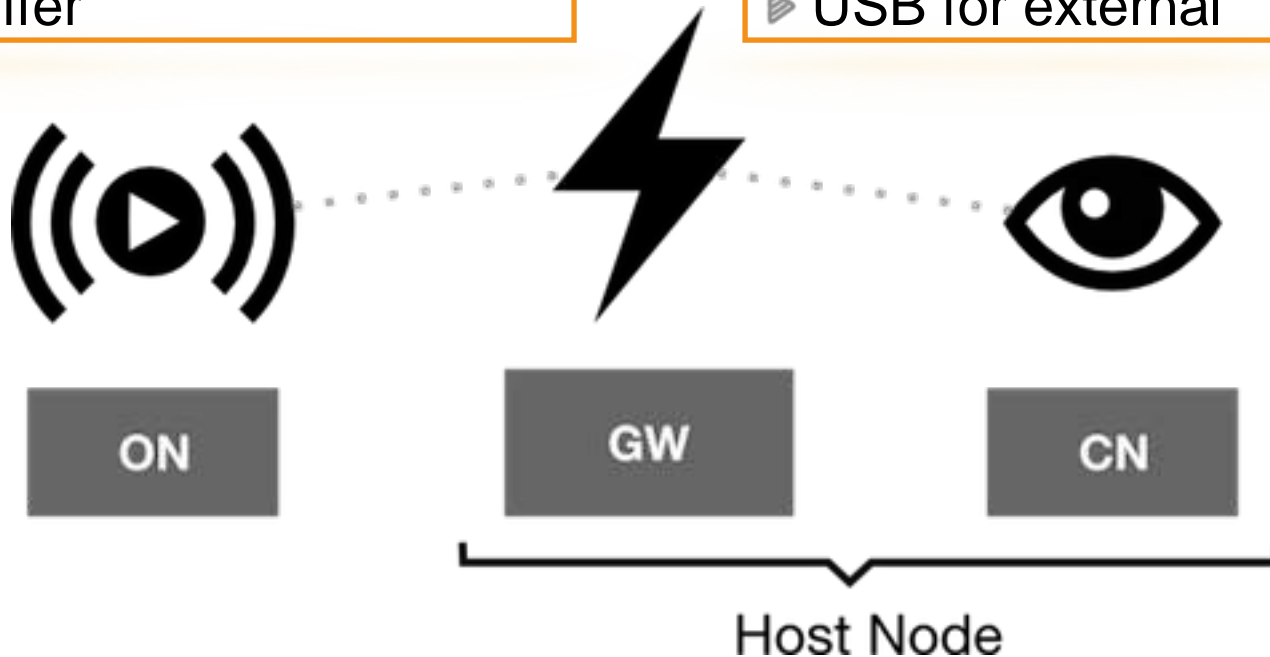

- connection to the global infrastructure
- control and monitor the open node.
- handles the open node serial link if the node is set to be a sink node.

IoT-LAB Node M3 Architecture

- ▶ Automatic firmware deployment
- ▶ Consumption Monitoring
- ▶ Sensor polling
- ▶ Radio sniffer

- ▶ Feedback channel
- ▶ Power over ethernet
- ▶ SINK / Internet connexion
- ▶ USB for external

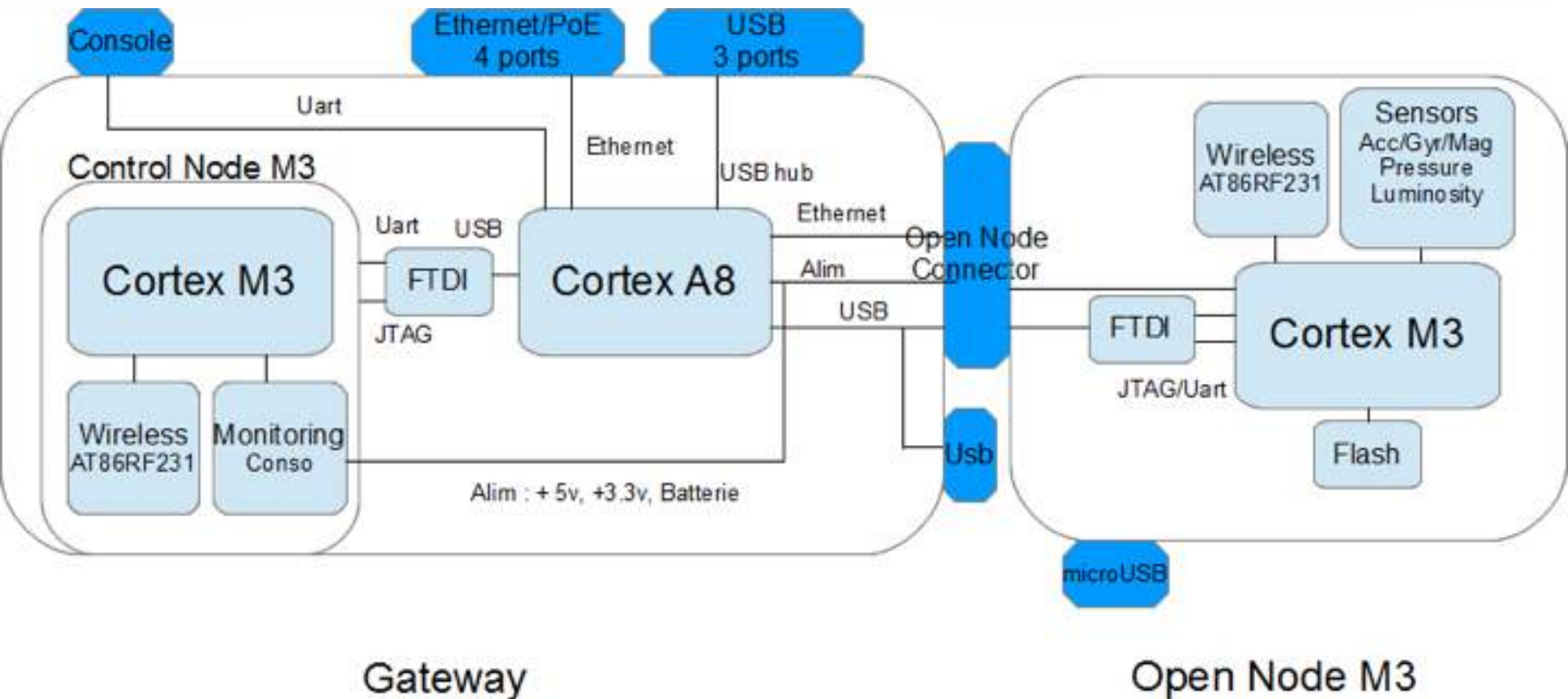





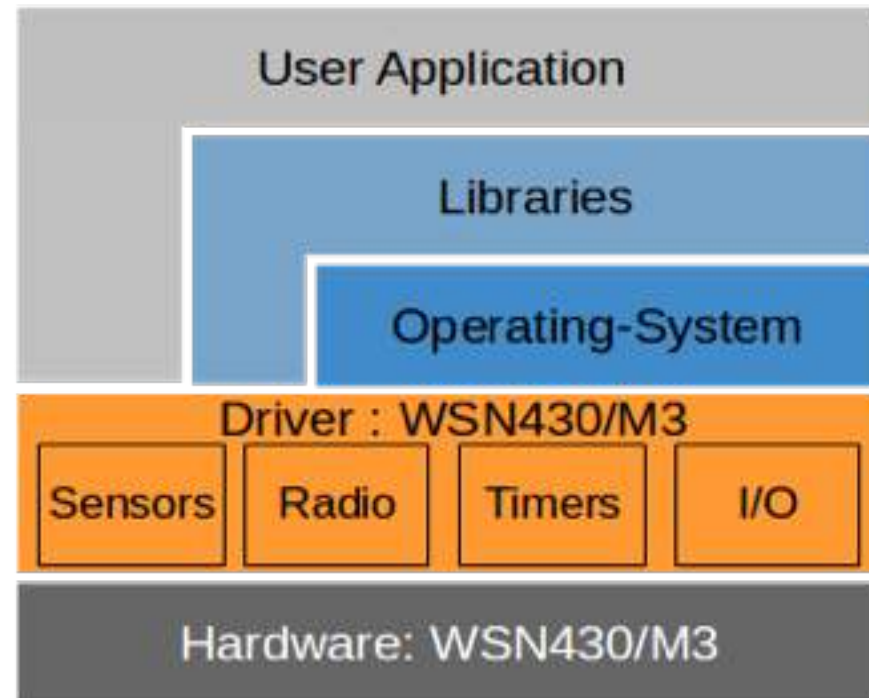

Embedded User Software

- ▶ IoT-LAB offers full support for embedded software development:
 - ▶ direct access to node HW
 - ▶ OS-level features
- ▶ Developers can leverage the different APIs to build applications.



CeCILL

Several Operating Systems

	WSN430	M3 NODE	A8 NODE
	<input checked="" type="checkbox"/>	<input checked="" type="checkbox"/>	
	<input checked="" type="checkbox"/>	<input checked="" type="checkbox"/>	
	<input checked="" type="checkbox"/>	<input checked="" type="checkbox"/>	
	<input checked="" type="checkbox"/>		
	<input checked="" type="checkbox"/>	<input checked="" type="checkbox"/>	
			<input checked="" type="checkbox"/>

What's about iot.eclipse.org ?

More than just an isolated testbed

▶ An Internet of Testbeds

- ▶ A **Facility** – A playground for the future Internet
- ▶ Wide-variety of eco-systems and develop openness

▶ Benefits from FIT / OneLAB.eu

- ▶ An architecture for federation
- ▶ Fundamental components for testbed federation
- ▶ **SFA aims to provide a secure common API with the minimum possible functionality to enable a global testbed federation**

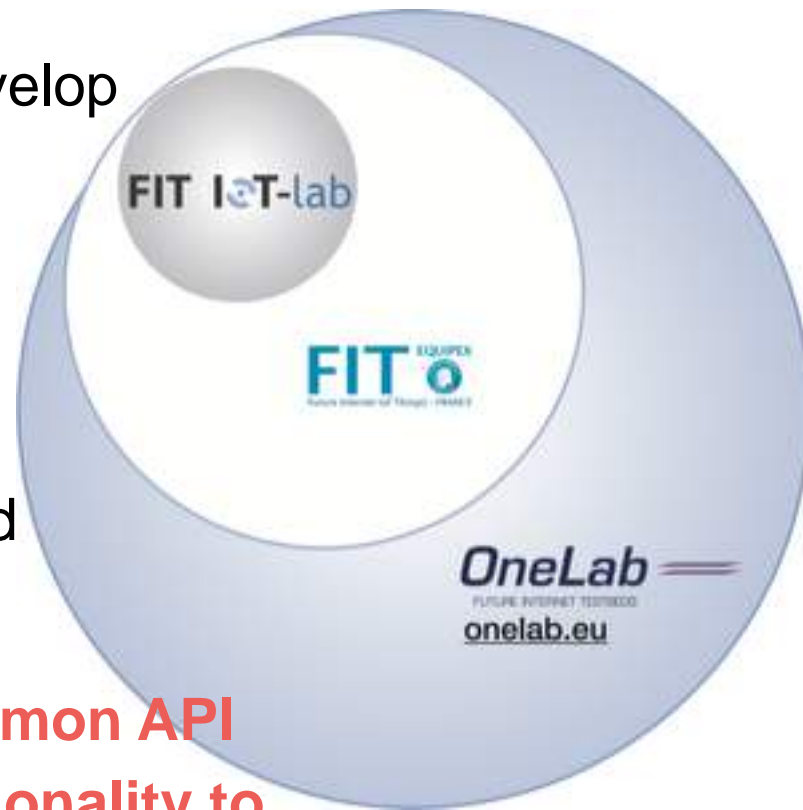

The issue with testbed isolation

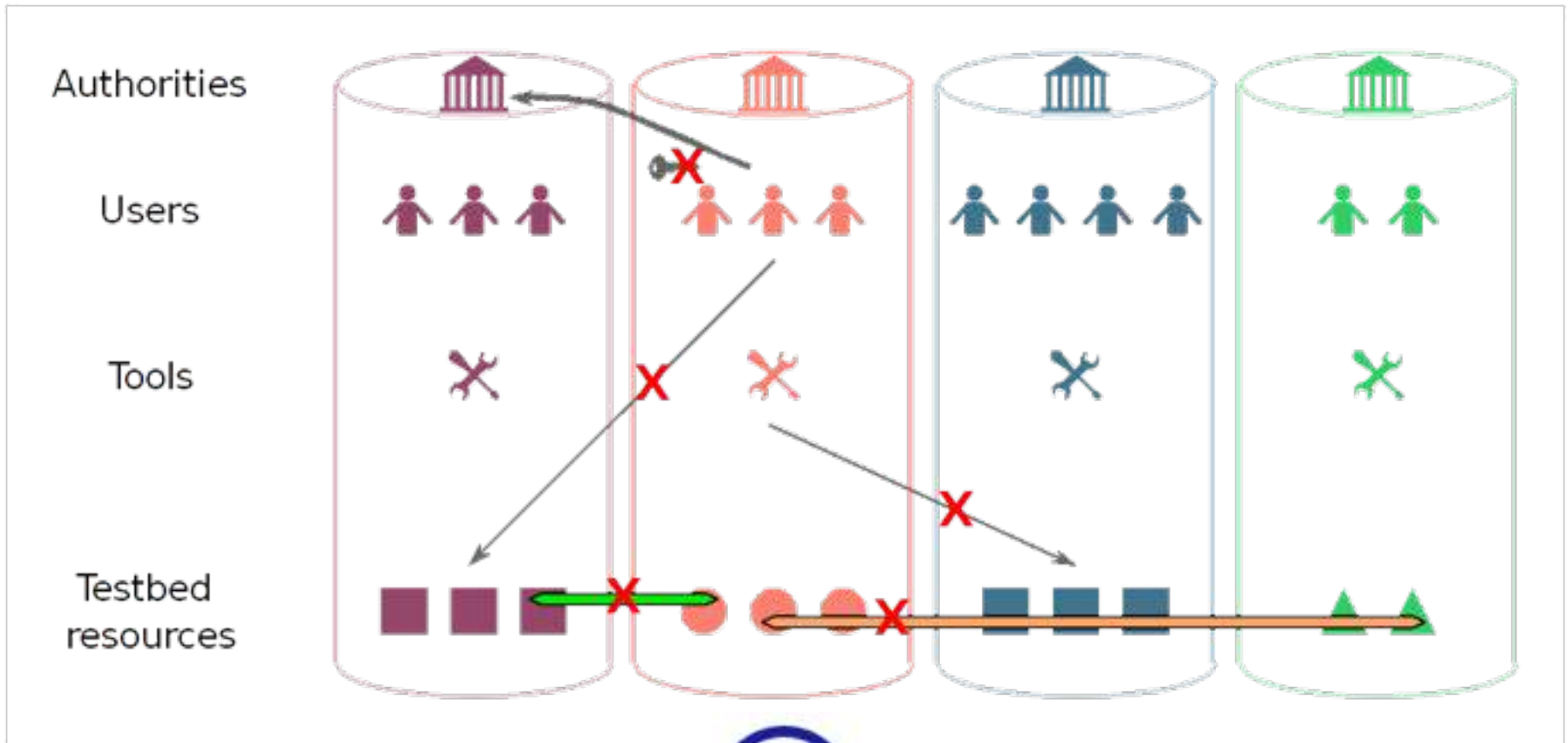

Experimenters

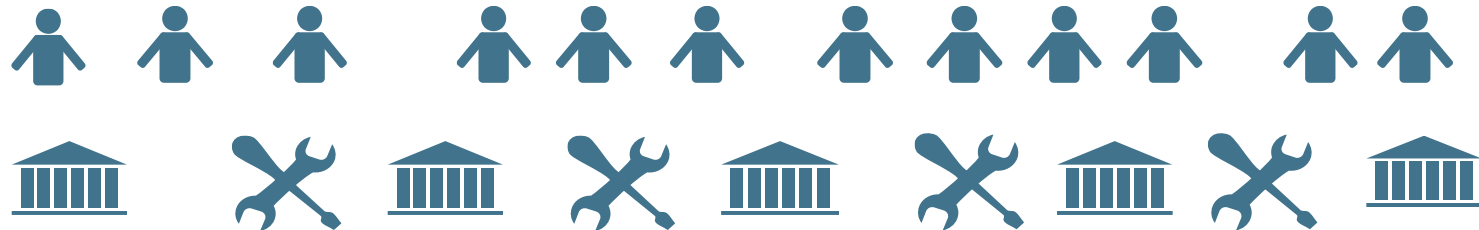

compliant to SFA (Slice-Based Facility Architecture)



Testbed resources

How to run an experiment

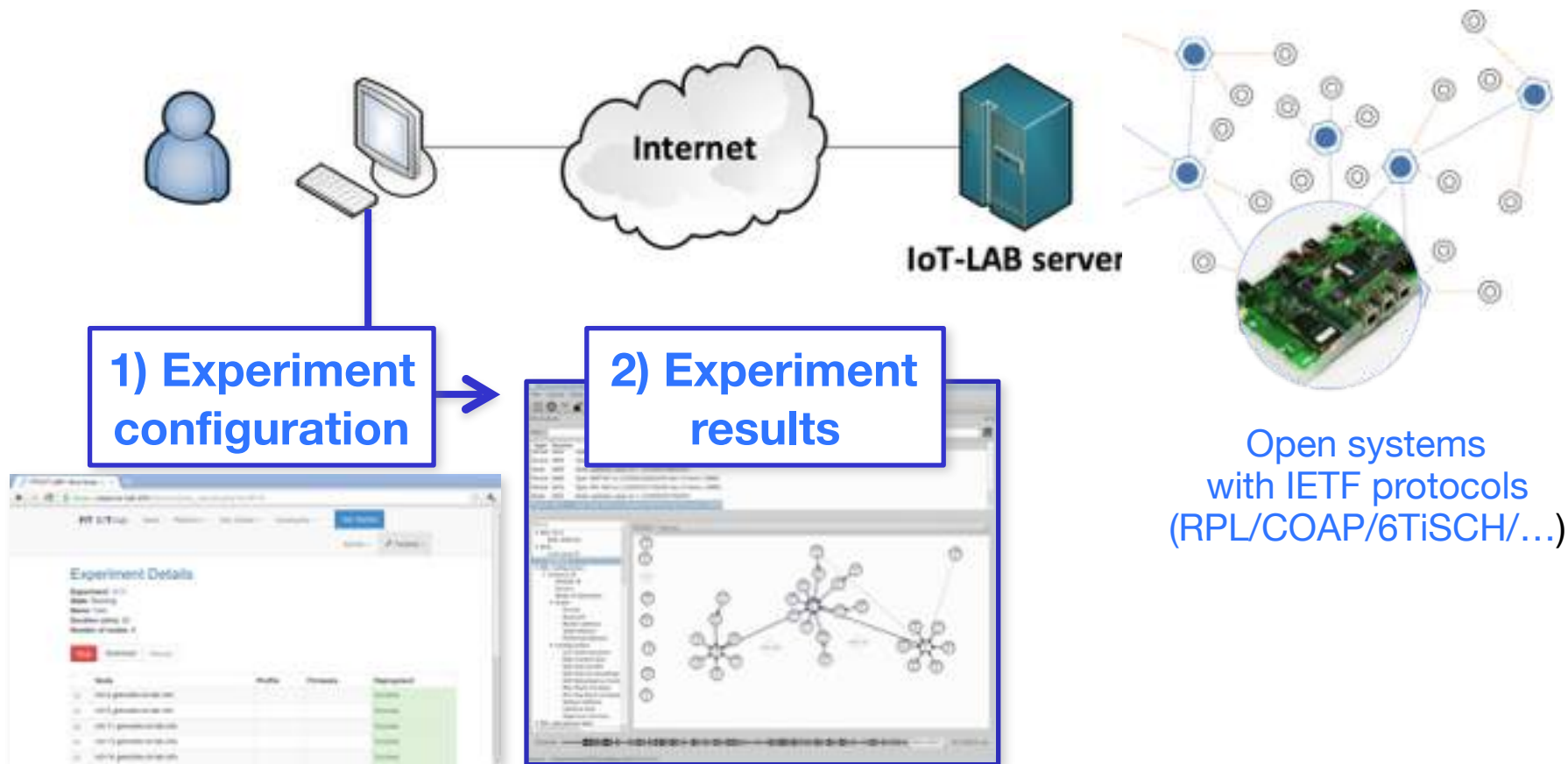

How to run an experiment

- ▶ Open a user account
- ▶ Ressources reservation
 - ▶ Geographical sites
 - ▶ WSN430/M3/A8 nodes
- ▶ Experimentation description
 - ▶ Firmware/nodes association
 - ▶ Monitoring tuning
- ▶ Experimentation launching
- ▶ Monitoring data analysis

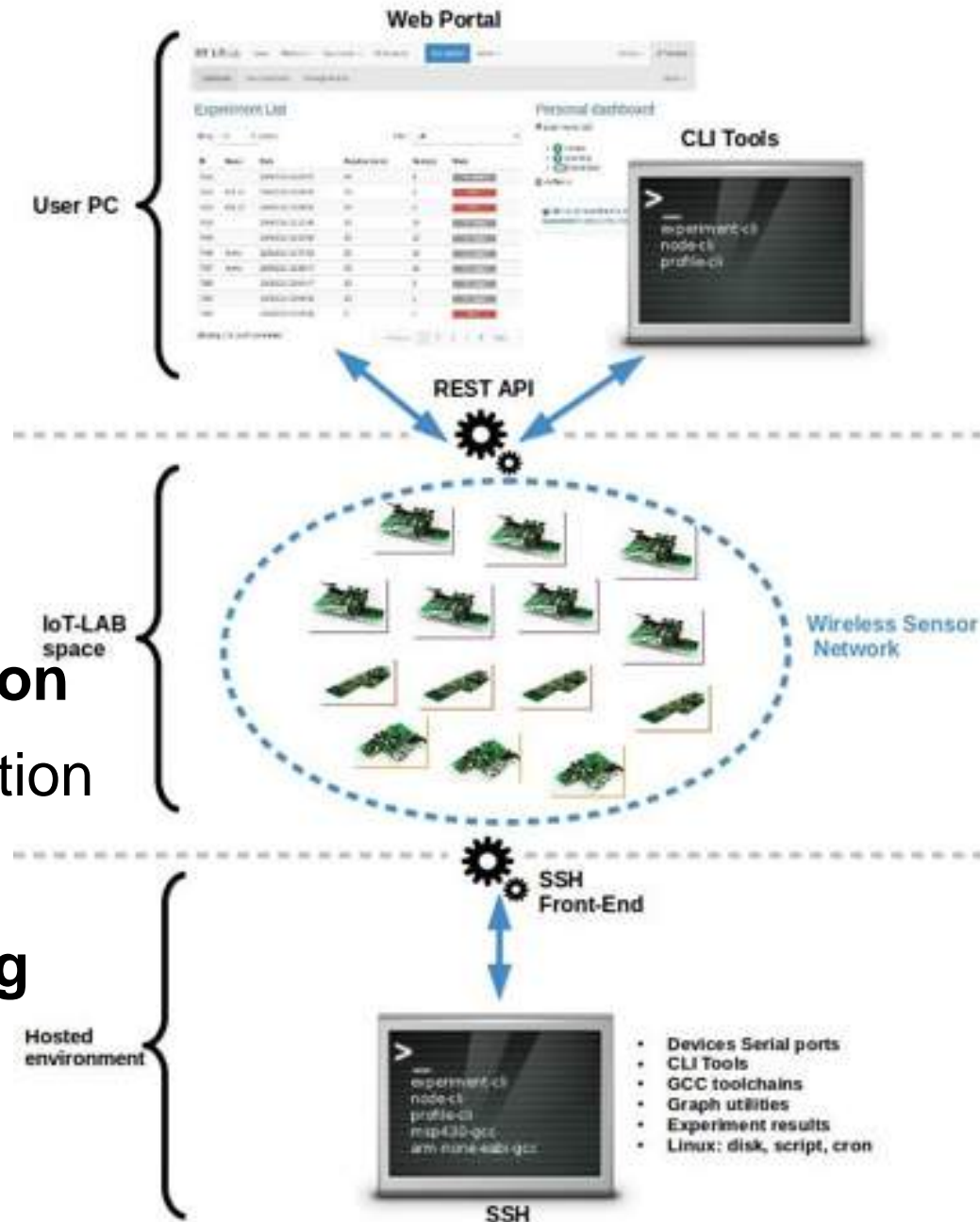

3

IoT-LAB Inria Grenoble IoT LAB Strasbourg Site

Demo

IoT LAB Inria Grenoble

- ▶ 256 WSN nodes
- ▶ 200/384 M3 nodes
- ▶ 256 A8 nodes
- ▶ 32 Open nodes

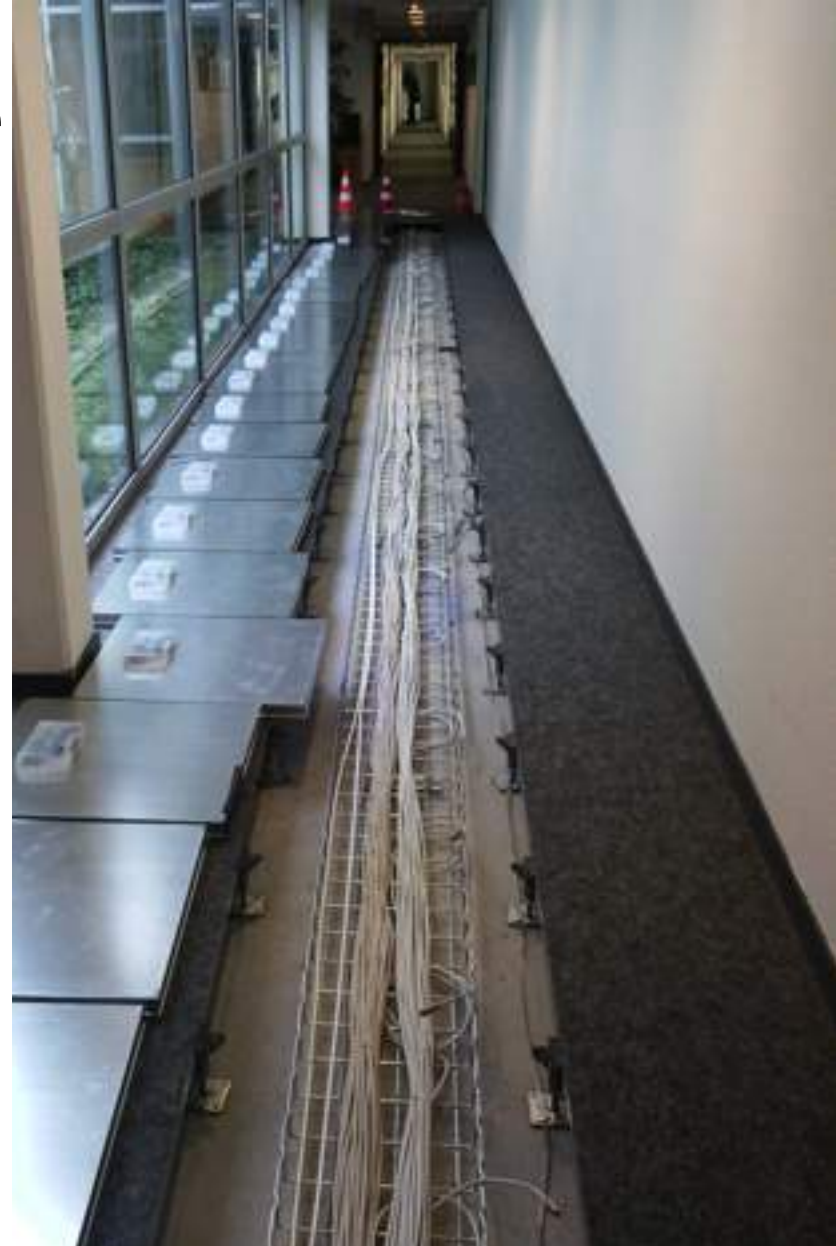
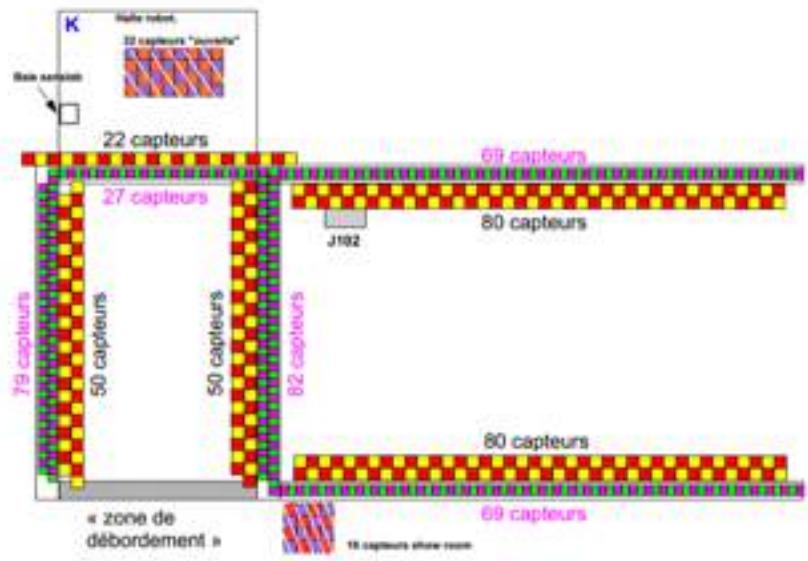

Contiki RPL IPv6 Experiment

FIT  **IoT-lab**

Inria
Informatiques mathématiques

FIT EQUIPEX
Future Internet (of Things) - FRANCE

Inria

Eric Fleury ENS de Lyon / Inria



FIT  **IoT-lab**

October 2015

Smart Tiles

for

Robots and Humans

Detection

IoT LAB Strasbourg

- ▶ 256 WSN nodes
- ▶ 120 M3 nodes
- ▶ 25 A8 nodes
- ▶ 40 mobile nodes

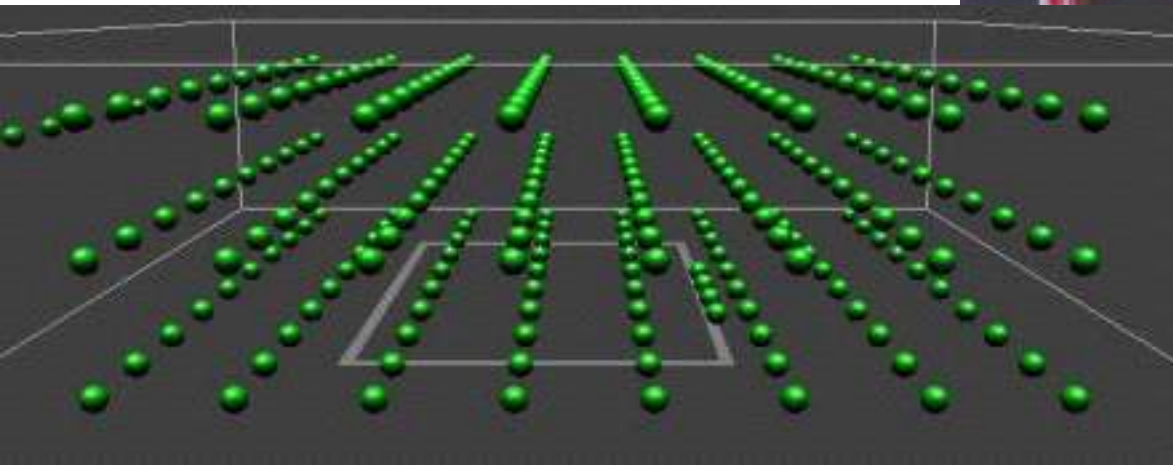
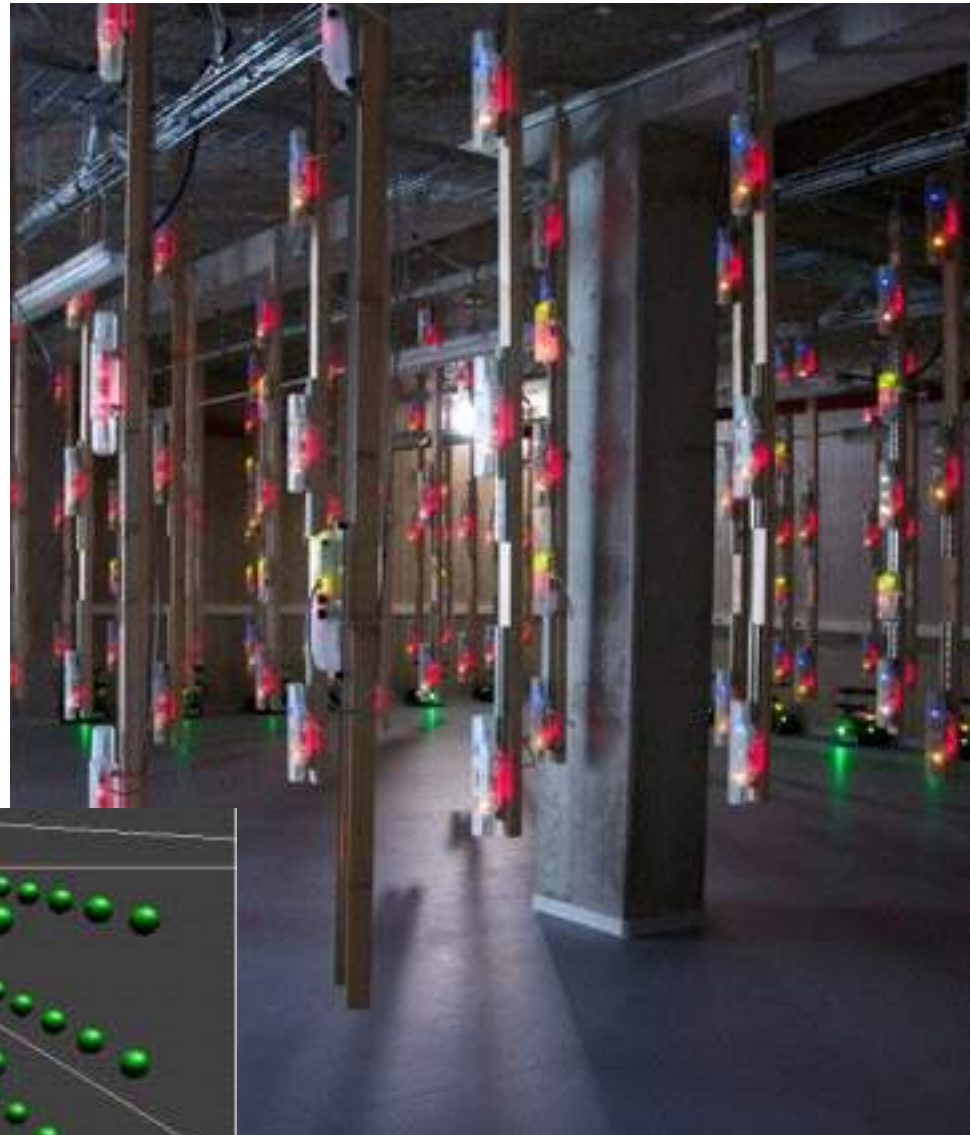



4

Conclusions

Time to use it !

▶ Statistiques

- ▶ more than 350 users registered
- ▶ in more than 45 countries
- ▶ 11K experiments launched



▶ Futur development

- ▶ Full IPv6 support end to end
- ▶ Open robots

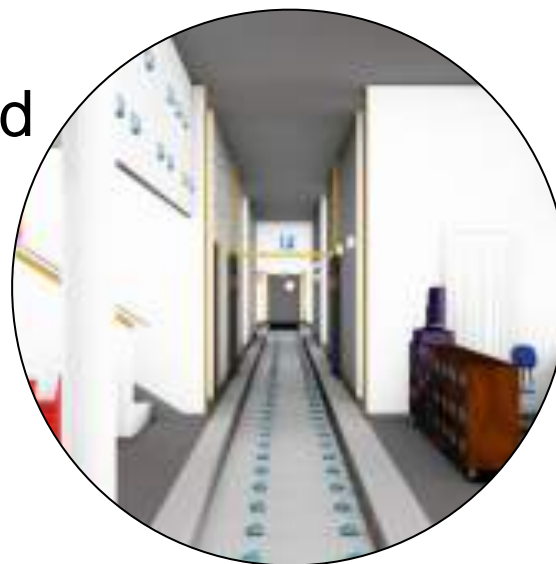

▶ H2020 calls on IoT

<https://www.iot-lab.info>

Huge collaborative and collective work

▶ Strasbourg

- ▶ Guillaume Schreiner
- ▶ Erkan Valentin

▶ Rocquencourt

- ▶ Ala-eddin Weslati
- ▶ Ichrak Amdouni
- ▶ Vincent Ladeveze

▶ Lille

- ▶ Julien Vandaele
- ▶ Loic Schmidt
- ▶ Anne-Sophie Tonneau
- ▶ Raymond Borenstein

▶ Grenoble

- ▶ Frédéric Saint-Marcel
 - ▶ Roger Pissard-Gibollet
 - ▶ Nicolas Turro
 - ▶ Gaetan Harter
 - ▶ Olivier Fambon
 - ▶ Sandrine Avakian
 - ▶ Fabien Vauvilliers
 - ▶ Jean-Francois Cuniberto
- ▶ C. Chaudet, N. Mitton, T. Noel, C. Adjih, E. baccelli

<https://www.iot-lab.info>

For more information

▶ IOT-lab

▶ <https://www.iot-lab.info>

▶ **Wiki:** <https://github.com/iot-lab/iot-lab/wiki>

▶ **Sources:** <https://github.com/iot-lab/>

▶ **Issues:** <https://github.com/iot-lab/iot-lab/issues>

▶ **Mailing-list:** users@iot-lab.info

▶ OneLab

FUTURE INTERNET TESTBEDS

▶ <https://onelab.eu>

▶ HIKOB

LEARN FROM REALITY.

▶ <http://www.hikob.com>

